

Optimization software linked to CATIA V5

Design space

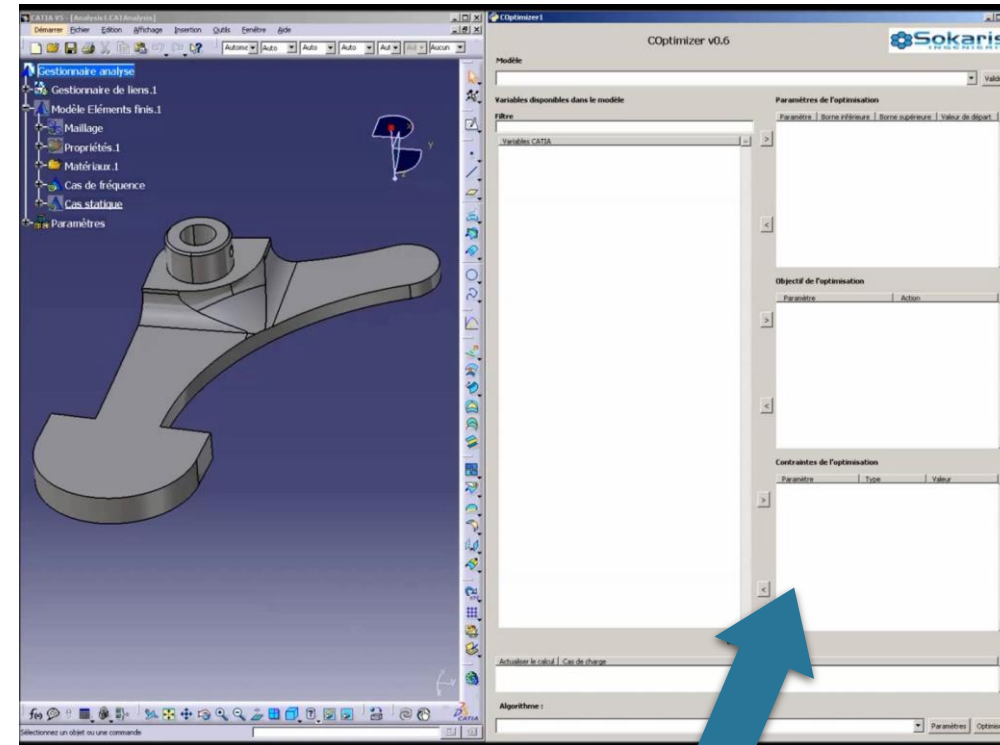

Topological optimization
to define a valid concept
in a range of frequencies
and inertia

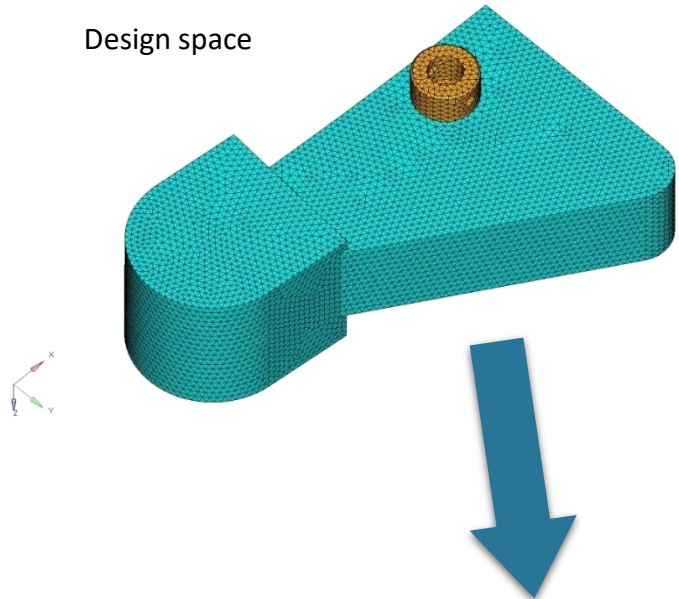
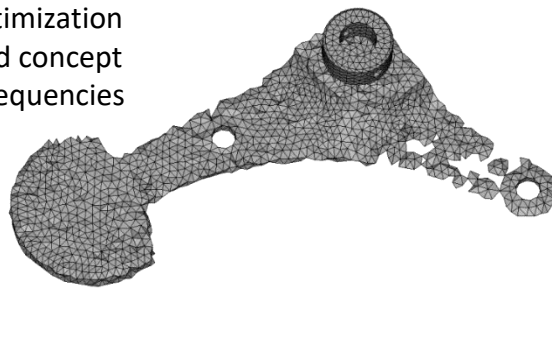

Concept digitalization
Generative model

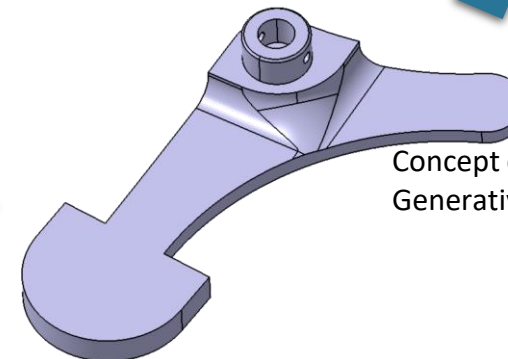

Parameters of the process (geometry, initial rugosity, speed...)



Parametric simulation ABAQUS / Python

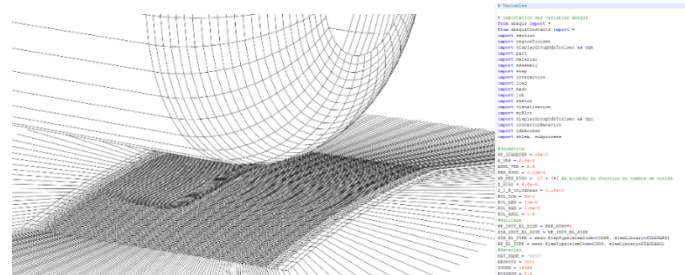

Rugosity

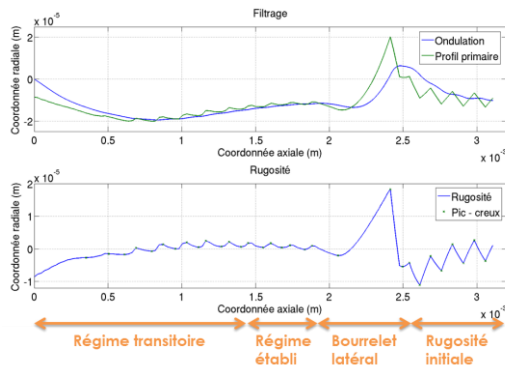

Residual stress

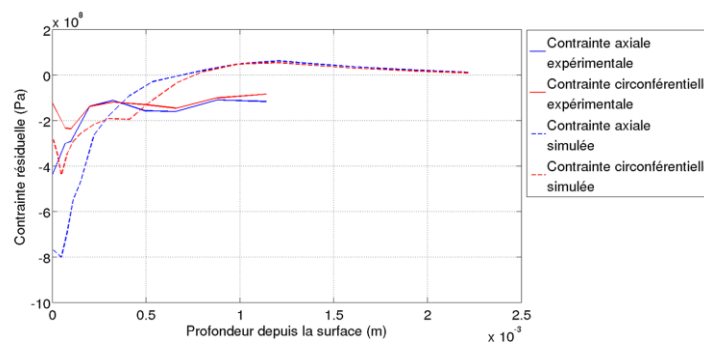

Toughness

